

琉球大学学術リポジトリ

Mechanisms of Legionella pneumophila-induced interleukin-8 expression in human lung epithelial cells

メタデータ	言語: 出版者: 公開日: 2007-12-10 キーワード (Ja): キーワード (En): 作成者: メールアドレス: 所属:
URL	http://hdl.handle.net/20.500.12000/2607

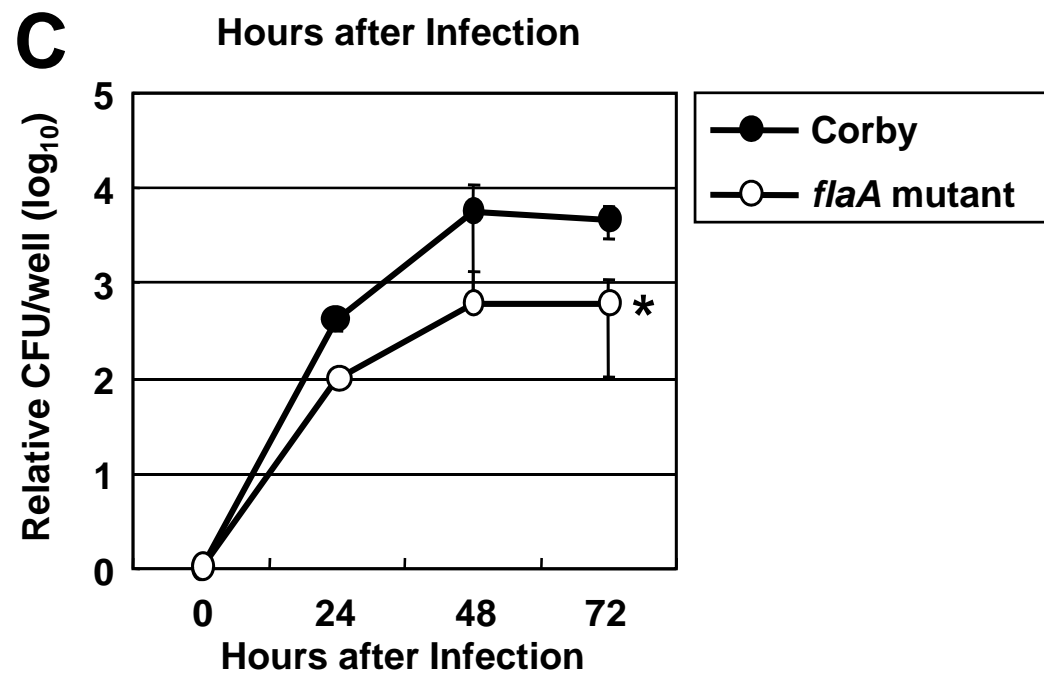

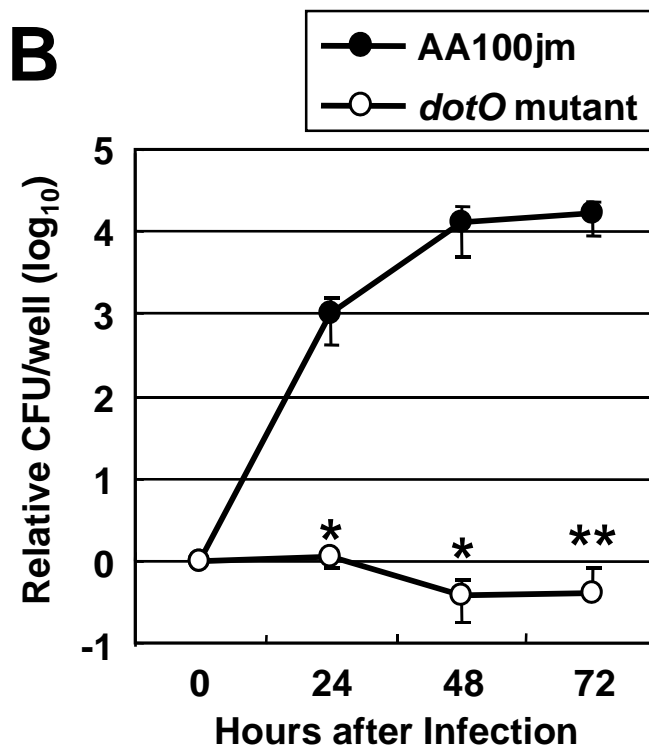
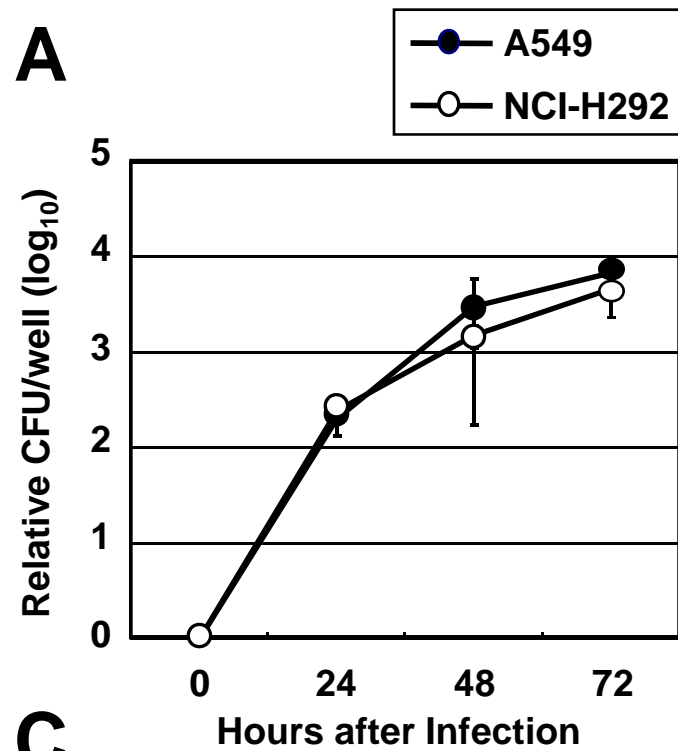
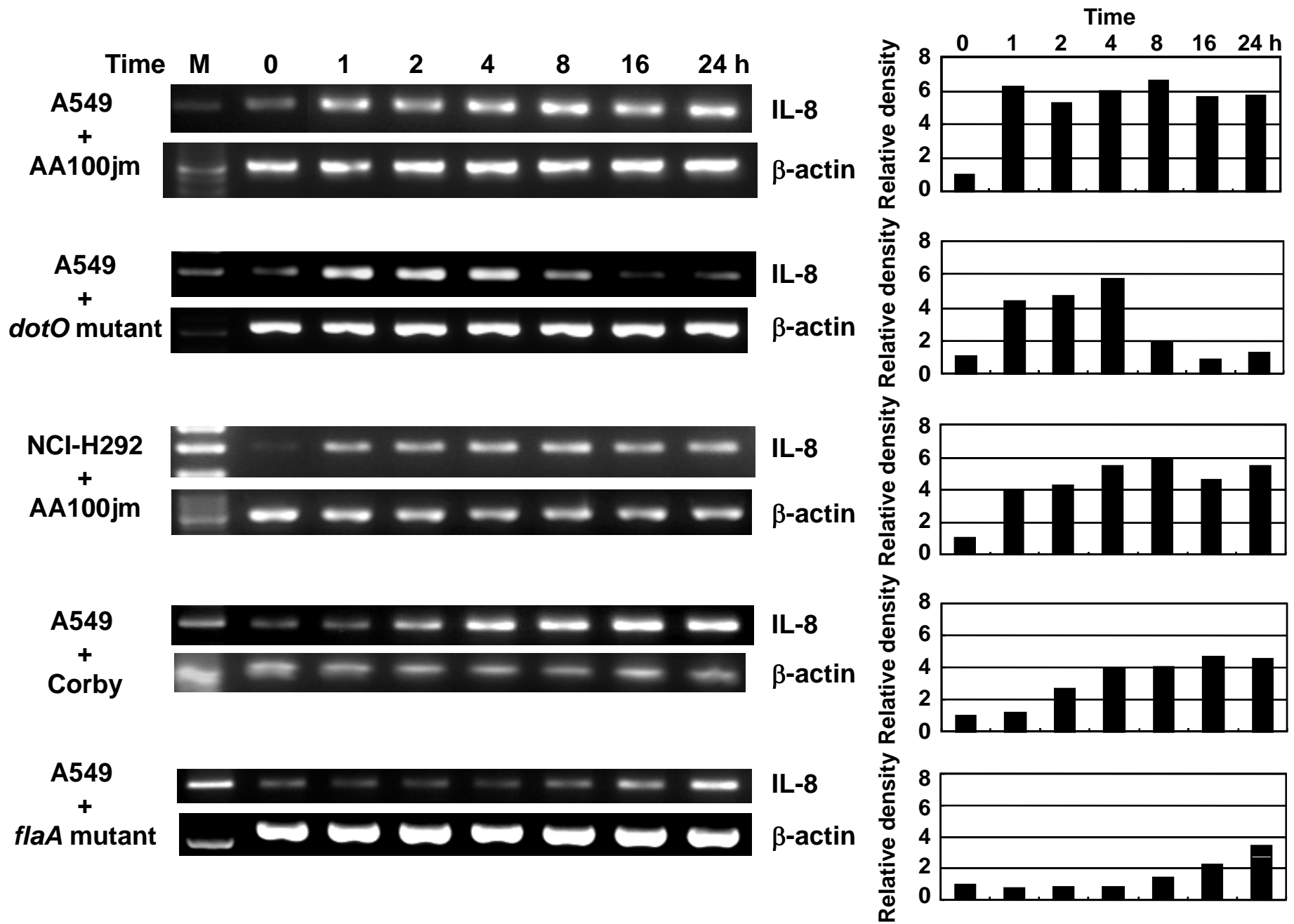

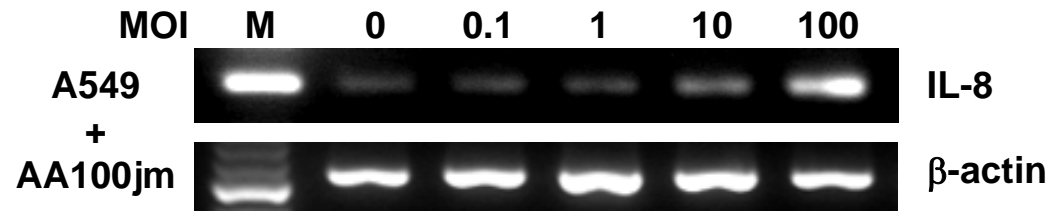
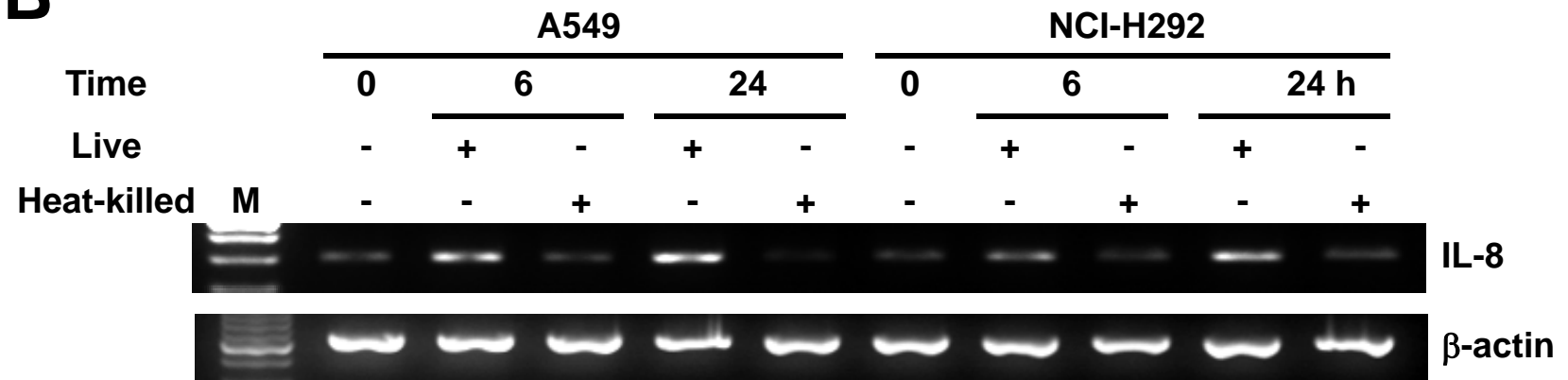
A**B**

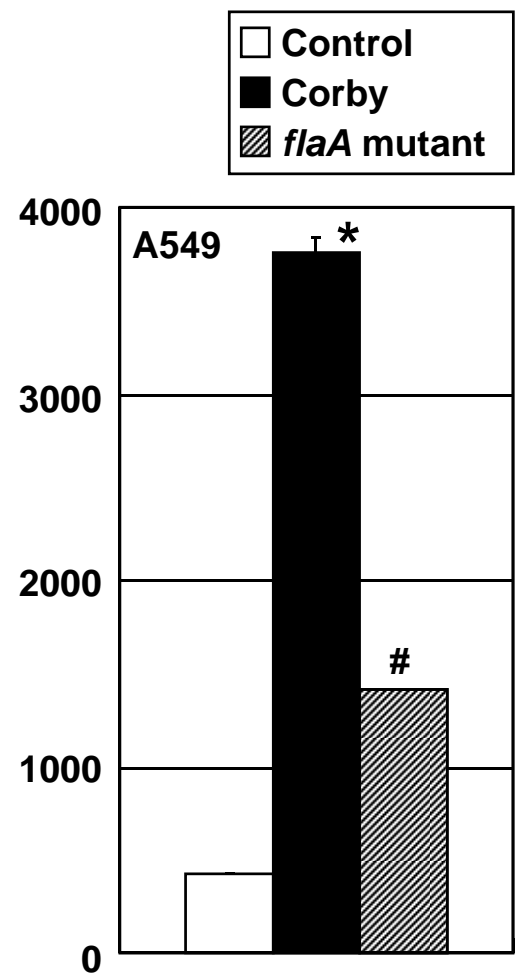
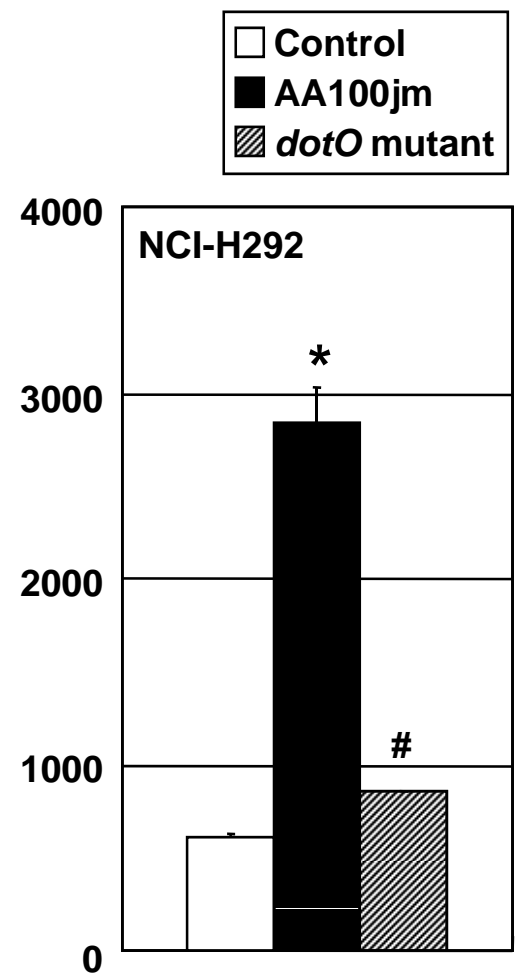
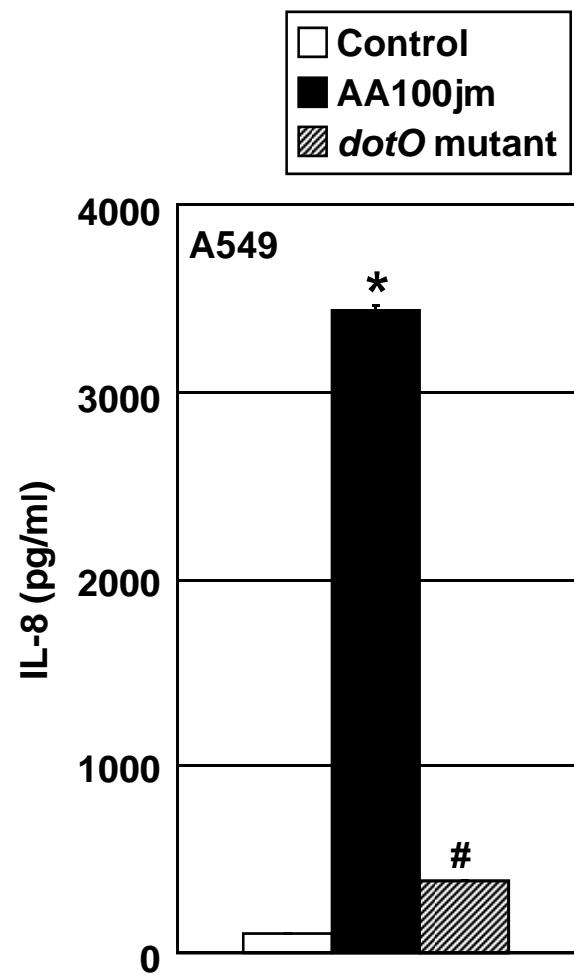

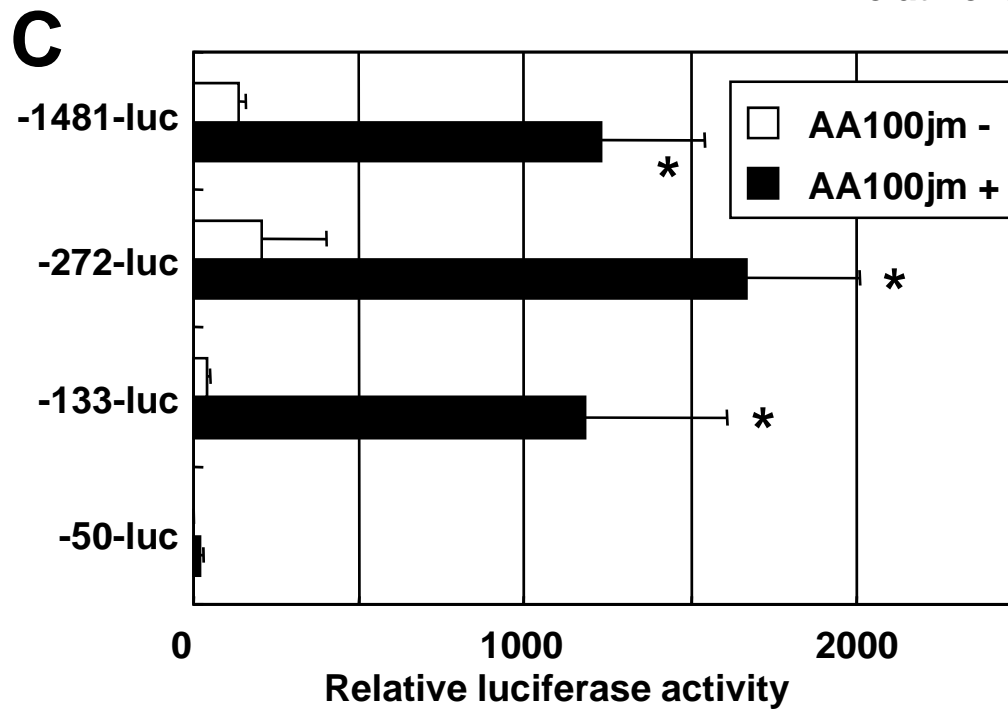
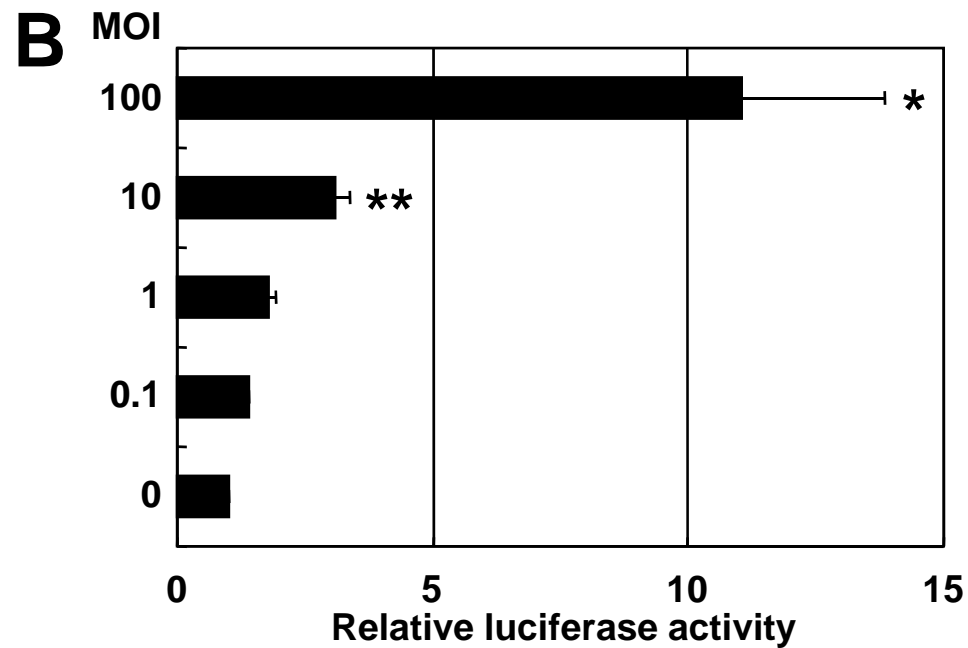
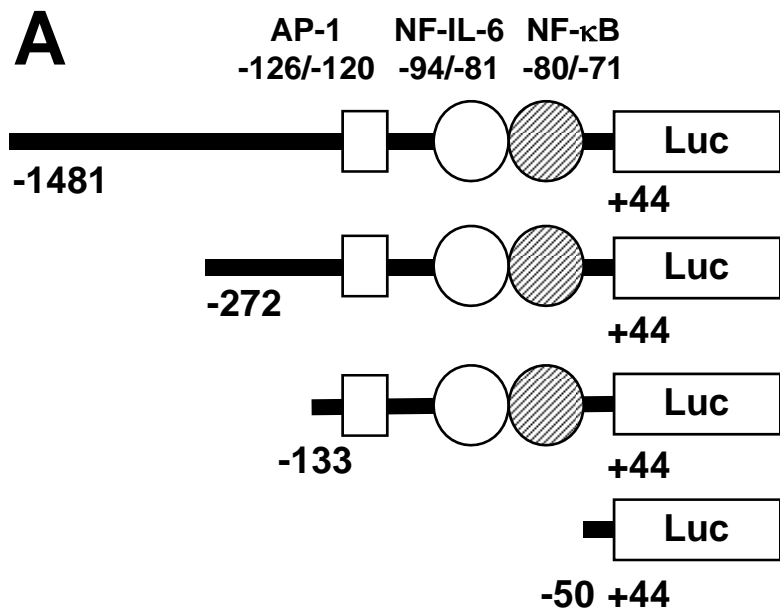

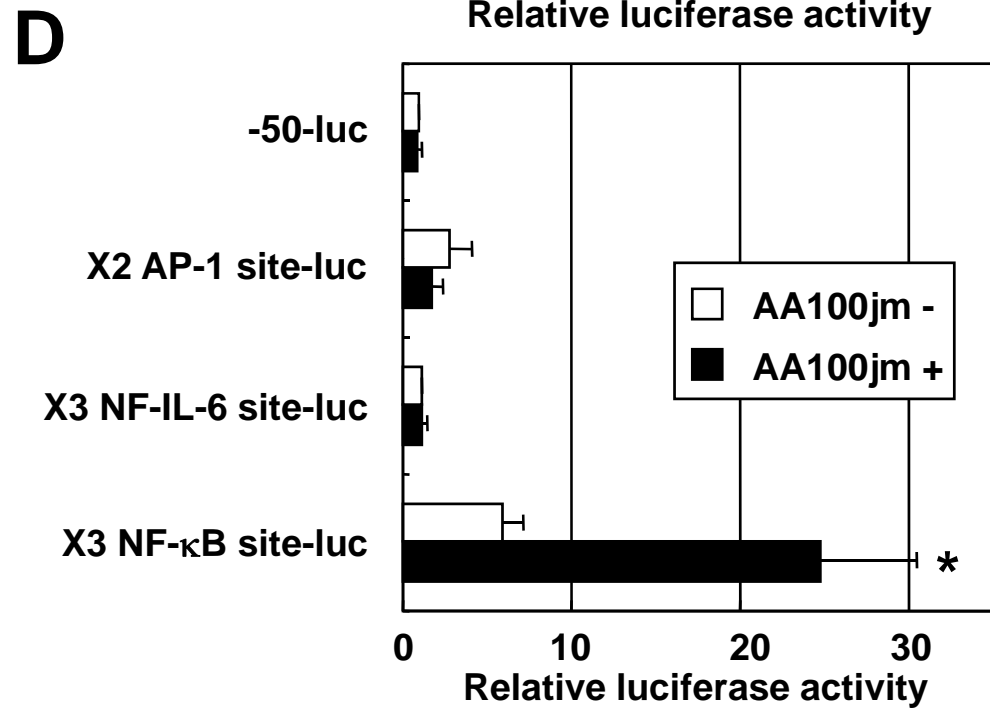
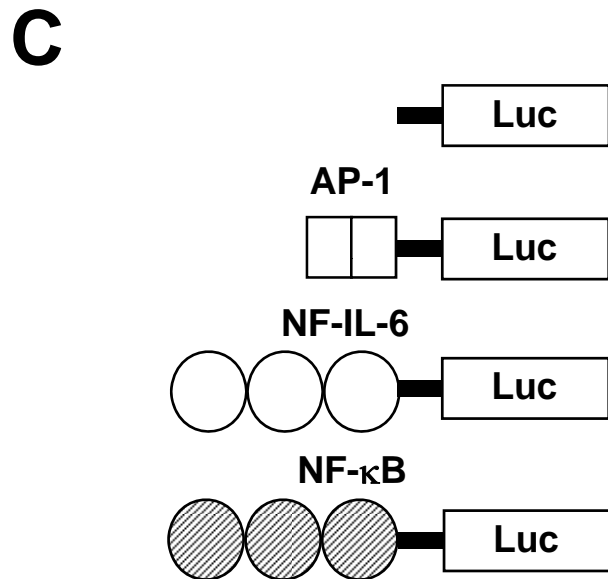
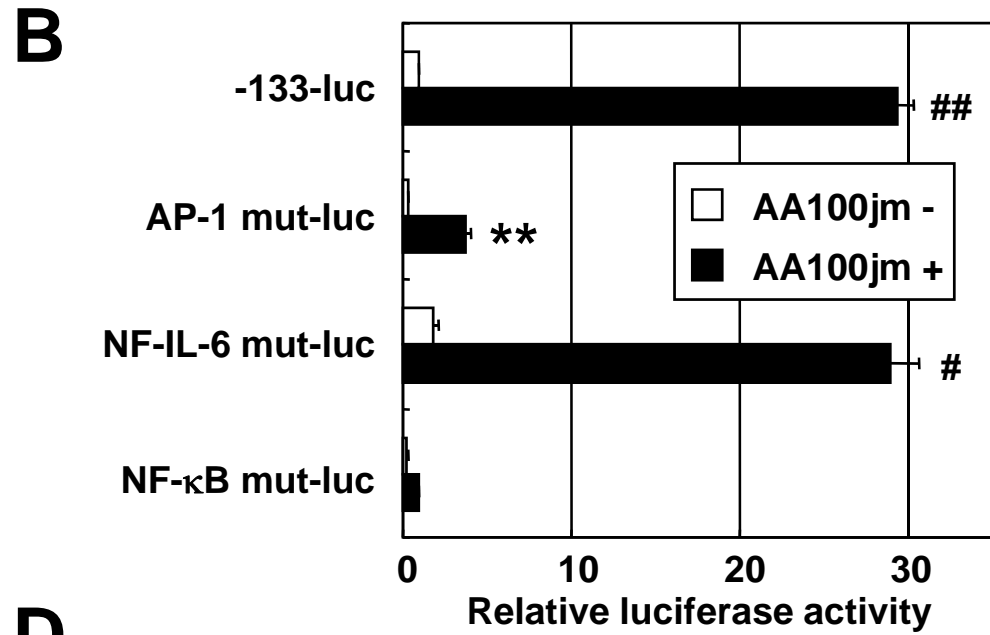
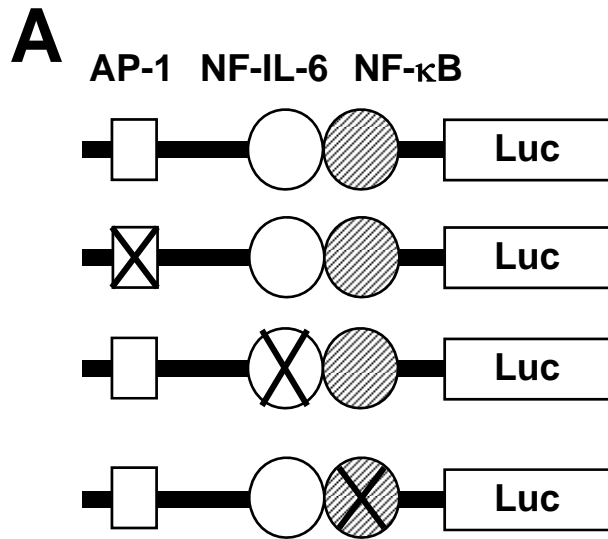

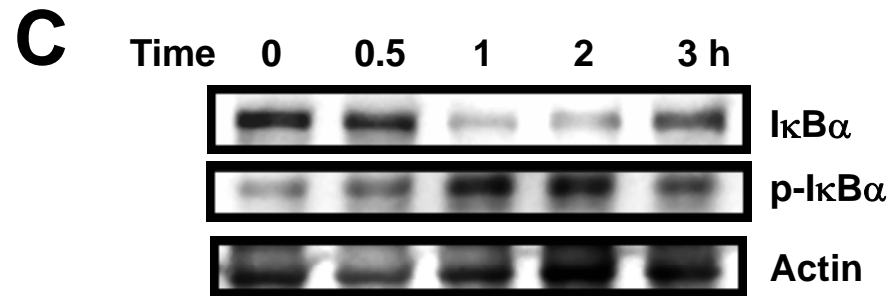
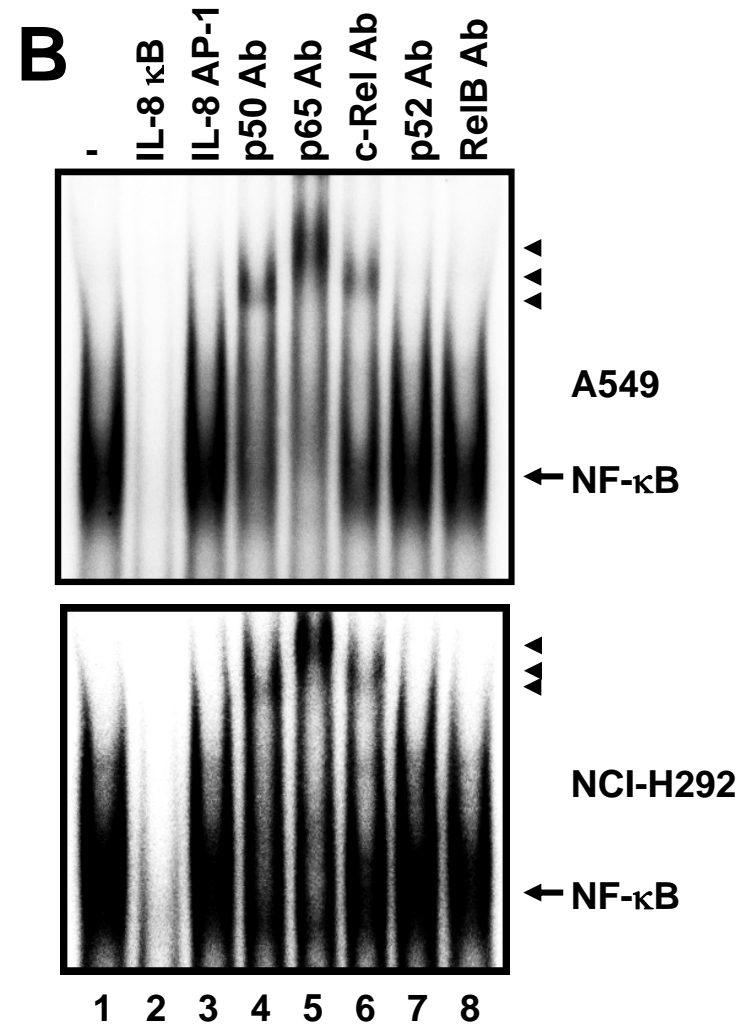
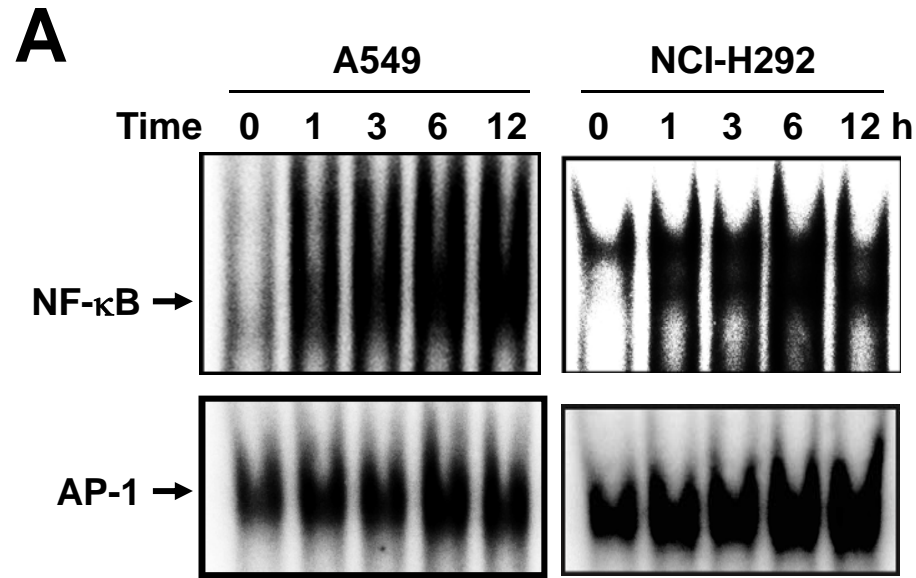

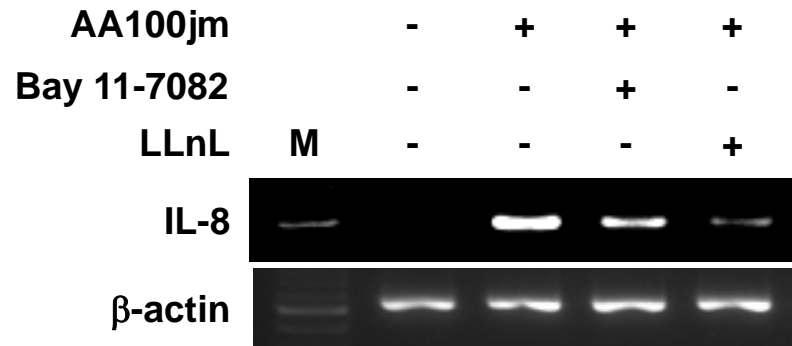
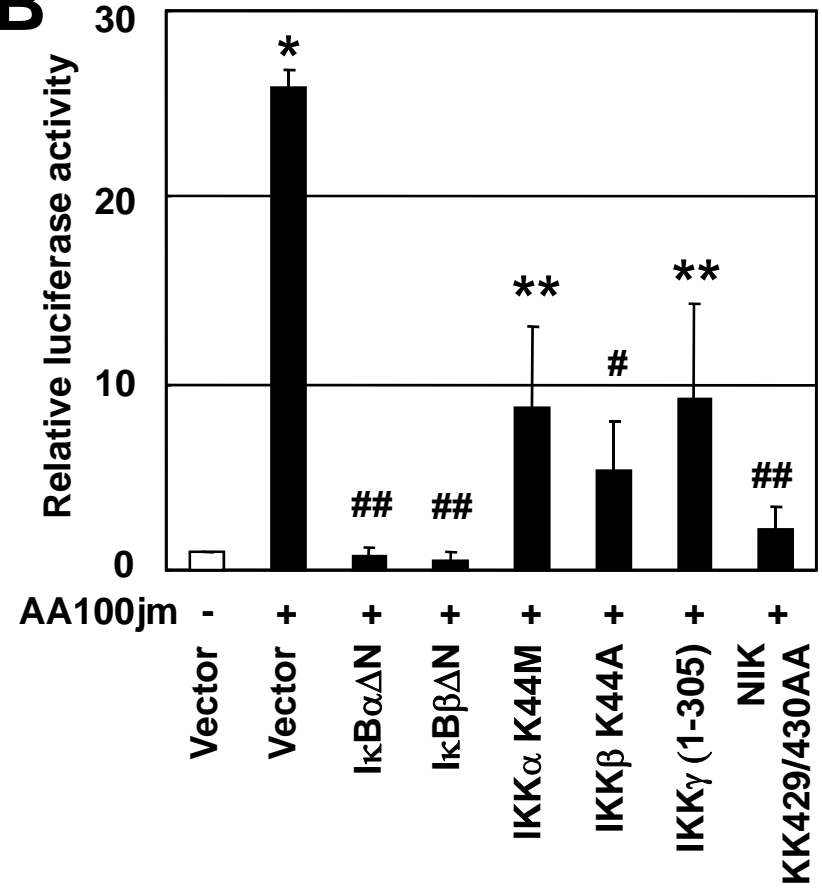
A**B**

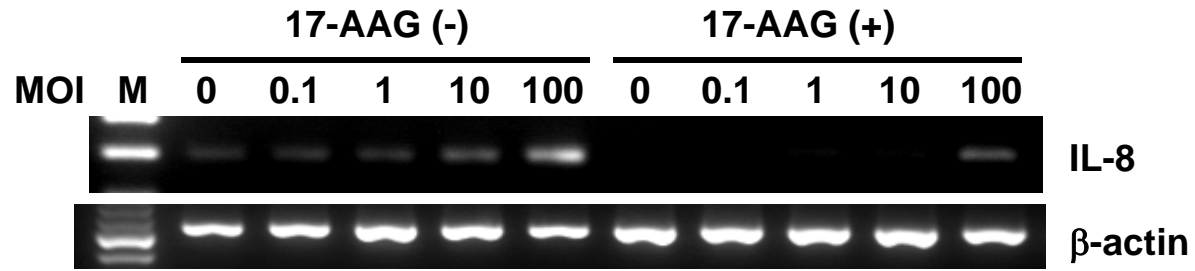
A**B**

MOI	0	10	100	0	10	100
17-AAG	-	-	-	+	+	+

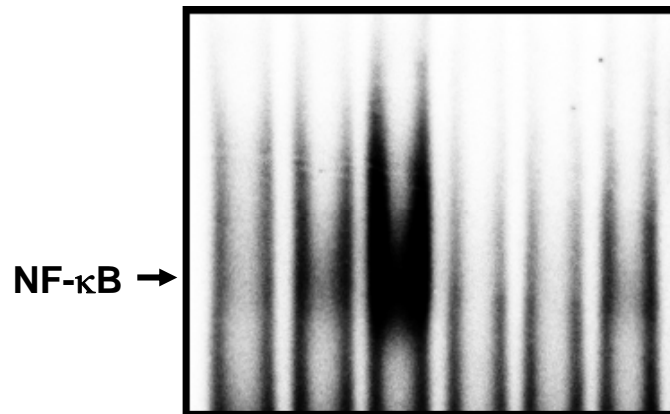
**C**