

# Hybrid Petri Nets Modeling for Farm Work Flow

Senlin Guan <sup>a,\*</sup>, Morikazu Nakamura <sup>a</sup> Takeshi Shikanai <sup>b</sup>,  
Takeo Okazaki <sup>a</sup>

<sup>a</sup>*Faculty of Engineering, University of the Ryukyus, 1 Senbaru Nishihara, Okinawa  
JAPAN 903-0213*

<sup>b</sup>*Faculty of Agriculture, University of the Ryukyus, 1 Senbaru Nishihara, Okinawa  
JAPAN 903-0213*

---

## Abstract

This paper introduces hybrid Petri nets into modeling for farm work flow in agricultural production. The main emphasis is on the construction of an adequate model for designing practical farm work planning for agriculture production corporations. Hybrid Petri nets conventionally comprise a continuous part and a discrete part. The continuous part mainly models the practical work in the farmland, and the discrete part mainly represents the status changes in resources such as machinery and labor. The proposed model also models the present status or undesirable breaks during the farming process. Moreover, in this paper, the approach of formulating the farm work planning problem based on the model is suggested. The simulated results reveal that the hybrid Petri nets model is promising for exactly describing the farming process and reallocating resources in the presence of uncertainties. The proposed model serves as a referential model for farm work planning and it promotes the development of a corresponding optimization algorithm under uncertain environments.

*Key words:* hybrid Petri nets, agricultural production, farm work flow, farm work planning, farm work scheduling, scheduling problem, modeling

---

---

\* Senlin Guan

*Email addresses:* guansid@gmail.com (Senlin Guan),  
morikazu@ie.u-ryukyu.ac.jp (Morikazu Nakamura).

## 1 Introduction

After World War II, Japanese agricultural land reforms were implemented to break up the structure of land ownership by state power-landlords and democratize rural communities. However, and undeniably, the reforms resulted in problems with shaping the Japanese agricultural land structure in the form of small-scale farm management and scattered patchwork farms. The Japanese government has shifted the direction of the agricultural land integration plan by setting out to promote land-leasing and securing contract for farm work with local owners so that land can be used efficiently. This policy has accelerated the integration of agricultural land into the hands of certified farmers, who aim for efficient and stable farm management, and agricultural production corporations established by an agreement of local farmers. As the result of these efforts to integrate agricultural land, there were, at a point, 190,000 management units serving as farmers/agricultural production corporations that aimed for efficient and stable farm management (The Ministry of Agriculture, Japan, 2006), and the number of these units is expected to further increase in the future.

These agricultural corporations lease and consolidate dispersed farmland and manage large-scale farmland with full mechanization. The fields managed by these corporations sometimes number over thousands and are scattered within a 10 km radius. Therefore, corporation workers have to move from field to field to carry out farm work. The scattered farmlands result in inefficient work and competition for limited farm resources such as machinery and labor during the cropping season. Moreover, farm work is poorly managed because the farmers are not accustomed to corporate management. Thus, farm work usually begins late in the season and the optimal time is often missed.

Scheduling of farm work and the selection and allocation of machinery and labor to finish field operations within a short span for effective crop production are critical decisions that farmers take on a daily basis. Although some farmers in these corporations are aware that a suitable farm work plan results in the efficient field operations, it is difficult for them to construct an optimum farm work plan. The daily work of employees in the agricultural production corporations is intensive, and they are rather accustomed to working by traditional experiences. Furthermore, many uncertainties in the farming process, such as changes in weather, machinery, and labor lead to troubles in planning work by the traditional method.

Some researches had been devoted to farm work planning based on information technology. The National Agricultural Research Center, Japan, had developed a Farming-systems Analysis and Planning System (FAPS) for paddy rice production based on a stochastic programming model (Nanseki, 1998). Daikoku

(2005) also developed a system for planning the work schedule of paddy rice production and transplantation in dispersed fields, and Nanseki et al. (2003) reported a farming-system database for farm work planning. In addition, models simulating a single operation (Miles and Tsai, 1987; Arjona et al., 2001; Higgins and Davies, 2005) and complete operation with one or more crops (Chen and McClendon, 1985; Tsai et al., 1987; Lal et al., 1991; Haffar and Khoury, 1992) have been developed. However, these models do not consider the daily schedule for allocating necessary resources to field operations for geographically dispersed farms, and the farmers could not easily understand the detailed farming progress for each farmland.

In order to formulate the farm work planning problem, it is useful to model farm work by mathematical modeling tools. Task graph (Djordjevic and Tomic, 1996) and Program Evaluation and Review Technique (PERT) (Cottrel, 1999) are well known methods for modeling the scheduling problem. A task graph is a directed acyclic graph and it is traditionally used to represent the precedence relation among tasks in scheduling problems. The graph is simple but does not include resource information such as machinery and labor. Scheduling algorithms require a task graph and resource information as the input data to calculate the optimal schedules. Usually, a task can be processed by a machine and the processing time is predetermined. The priority list scheduling algorithm (Sinnen and Sousa, 2001) is commonly utilized for such problems. The PERT is a model for project management and a method to analyze the task flow diagram for completing a project, the time required to complete each task, and the minimum time required to complete the entire project. It is useful for traditional scheduling problems. However, the task graph model and the PERT chart are not suitable for farming work since the processing time for a task changes with the available resource. A model for farming work scheduling problem must therefore be able to represent the changes in the processing time.

Since the conventional approaches mentioned above cannot be satisfactorily used to model farm work flow for geographically dispersed farms, we have developed a new model that uses a Petri net. We verified the applicability of the discrete Petri net model by the simulation of farm work planning proposed by Guan et al. (2006a), and we found that farmers could easily understand the details of the farming process from a pictorial description of work flow. However, a simple Petri net can only model the entire schedule in a crop growth cycle. The stochastic nature of weather and the complexity of other factors such as accidents involving the machinery complicate farm work modeling. Once uncertainties appear, the components of the Petri nets model should be changed in order to adapt the model to environmental changes. As a consequence, a simple Petri net is inadequate to model a practical farm work plan and requires improvement if uncertainties are to be considered.

Farming operations involve discrete events as well as continuous processes. Uncertainties such as machinery failure and breaks are discrete events. On the other hand, once a farm work has started operation, a continuous process is created that is controlled by the work rate, which is determined by the capability of labor, the efficiency of the machinery or a combination of both these factors. This shows that discrete events and continuous processes correspond to the continuous and discrete Petri net model in hybrid Petri nets, respectively. Several researches on hybrid Petri nets model have been developed in recent years (Febbraro and Sacco, 2004; Kaakai et al., 2007; Dotoli et al., 2007). Thus far, however, few researches have introduced the Petri nets model for representing farming process, and no research on hybrid Petri nets for farming work exists.

In this study, we concentrate on only designing an appropriate model for modeling farm work flow for geographically dispersed farms. For this, we considered the farming of sugarcane, which is an important crop and is used as a base crop for agriculture in Okinawa, Japan. We used sugarcane farming to demonstrate the ability of the model to construct farm work flow in an agricultural corporation. Preliminary notes on Petri nets and modeling for cases of farming work are presented in Section 2. Section 3 provides a scheme for formulating the farm work planning. In Section 4, we show the result simulated by the hybrid Petri nets. The paper ends with a discussion and the conclusions.

## 2 Preliminary notes on Petri nets

### 2.1 Discrete and continuous Petri nets

A Petri net is a graphical and mathematical modeling tool for describing and simulating dynamic and concurrent activities of systems (Murata, 1989). It is widely used in computer systems, manufacturing systems and discrete-event systems. A Petri net is graphically represented by a directed bipartite graph, and it contains structural components of places, transitions, and arcs (Fig. 1(a)). In a Petri net, places drawn as circles are used to describe local system states, and transitions drawn either as bars or boxes are used to describe events that may modify the system state. Arcs that connect places and transitions represent the relations between local states and events. Tokens are drawn as black dots within places.

A Petri net  $\mathcal{N}$  can be formally defined as  $\mathcal{N} = \langle P, T, Pre, Post \rangle$ , where  $P$  is a set of places;  $T$ , a set of transitions;  $Pre$  ( $Post$ ), the pre- (post-) incidence function representing the input (output) arcs. A Petri net in which the initial marking  $m_0$  is completely specified is called as a Petri net system

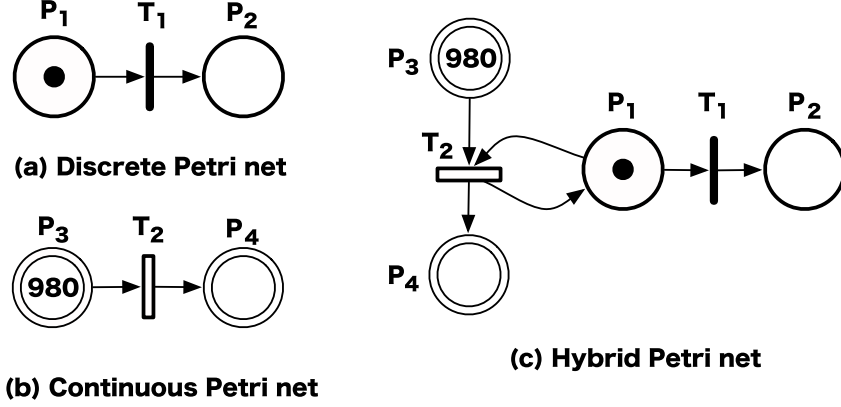

Fig. 1. (a) Discrete Petri net, (b) Continuous Petri net, (c) hybrid Petri nets

$\mathcal{N} = \langle P, T, Pre, Post, m_0 \rangle$ , where  $m_0$  is a function representing the initial number of tokens in each place.

In comparison with discrete Petri net, the marking of places in continuous Petri net is marked by real numbers, and the transition firings are continuous processes. The continuous Petri net usually models a continuous system or approximates a discrete system. Figure 1(a) and (b) illustrate discrete Petri net and continuous Petri net, respectively. In the discrete and continuous Petri nets, the transformation of the marking of places satisfies the following fundamental relation:

$$m = m_0 + A \cdot s \quad (1)$$

where  $A$  is the incidence matrix and  $m_0$  is the initial marking of places.  $m$  represents the current marking of places. The characteristic vector  $s$  of a firing sequence implies a string of successive markings and is a vector corresponding to the number of firings of the corresponding transition. Unlike the vector  $s$  represented by an integer in the discrete Petri net, the vector  $s$  in the continuous Petri net comprises a series of real numbers.

## 2.2 Hybrid Petri nets

In many cases, work process may be approximately modeled for continuous flow, but the state of resources is necessarily discrete. Hence, the hybrid Petri nets model is considered for modeling such systems (David and Alla, 2001). A hybrid Petri nets system is defined as  $\mathcal{N} = \langle P, T, Pre, Post, m_0, h \rangle$ , where  $P, T, Pre, Post, m_0$  are quite similar for a discrete Petri net, and  $h$  is a hybrid function that indicates a discrete or continuous node. Hybrid Petri nets informally contain a discrete part and a continuous part (Fig. 1(c)). Considering

the time for the hybrid Petri nets, the marking  $m$  at time  $t$  of hybrid Petri nets can be written as:

$$m(t) = m(0) + A \cdot \left( n(t) + \int_0^t v(u) \cdot du \right) \quad (2)$$

where  $A$  is the incidence matrix, and  $n(t)$  denotes the number of firings of the discrete transitions from the initial time to time  $t$ .  $v(u)$  is the firing speed of the continuous transitions at an arbitrary time  $u$ .

### 3 Hybrid Petri nets modeling for farm work flow

In this research, we design a model for describing working flow in the production of sugarcane, which is grown in three crop classes: spring plant crop, harvested in the first winter by planting in spring; summer plant crop, harvested in the second winter by planting in summer; and ratoon crop, harvested in the first winter by growing the bud after the cane field has been harvested. Most farm works in these crop classes are similar in a single farmland. The major farm works for spring plant crop involve plowing, seeding, planting, fertilizing, irrigation and harvesting. Each farm work requires allocating resources such as machinery and labor.

#### 3.1 Modeling farm work flow in one farmland

We define farm work operation as the transition, condition, or status of a farmland or a resource as the place, and resources like labor or machinery are defined as tokens in the Petri nets model. Figure 2 illustrates Petri nets modeling for farm work flow in one farmland. The circles  $P_{1i}$  and  $P_j$ , which are places, represent the status of the farmlands and resources. The real number in place  $P_{1i}$  represents the amount of farm work. The place  $P_{1i}$  is assigned with a waiting time for the next work. The tokens represented by dots indicate the resources. The transition  $T_{1i}$ , which is indicated by a bar or box, corresponds to the execution of farming work. The tokens in  $P_1$  are different from those in  $P_2$  because the farm work in both cases is not the same. According to the firing rule of a Petri net, transitions are enabled for execution when tokens satisfy the firing condition. This implies that the corresponding cultivation will be carried out when the conditions for cultivation and the labor and machinery requirement are satisfied. The working time for a farm work corresponds to the firing time of a transition. When the farming work is completed, the farmland

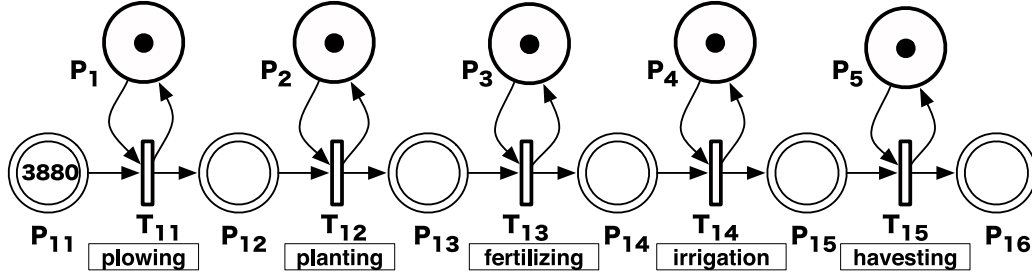

Fig. 2. Hybrid Petri nets modeling for farm work flow in sugarcane production

switches to a new status while labor and machinery are released and ready for other works.

In the figure,  $P_{11}$  indicates that the farmland is ready for the work of plowing. Along with the execution of the subsequent work with the available resources in  $P_1$ , the value in  $P_{11}$  decreases while that in  $P_{12}$  increases. When the plowing is completed, the values in  $P_{11}$  and  $P_{12}$  reach 0 and 3,880, respectively, and the resources in  $P_1$  are released. In practical farm work, some works such as fertilization are not performed immediately after planting. The work of fertilization is performed in a specific duration considering the growth of crops. In this Petri nets model, the waiting time is associated with the place. Therefore, the next work  $T_{12}$  cannot be started immediately since the place  $P_{12}$  is not available despite its token being greater than 0. The status of place  $P_{12}$  will be enabled and ready for the next cultivation after the waiting time. The integral model for multiple farmlands in an agricultural corporation is based on this elementary model (Guan et al., 2006a).

### 3.2 Cooperative farming work

A farming corporation takes possession of various farming machinery for carrying out farming work in the farmland in a variety of site conditions; consequently, farming work is performed with diverse machinery. For example, the work of fertilization can be performed with tractors whose horsepower is 15, 32, 47, and so on. Generally, farmers perform farming work with single or multiple machinery based on conventional experience. In the case of multiple machinery, the machines start working at different times, so that the rate of farming work depends on the allocated machinery. Cooperative farming work is defined as a process where multiple machines perform the same work, and it is modeled as shown in Fig. 3.

In this figure, the three transitions correspond to the same task being carried out by different arrangements of resources  $M_1$ ,  $M_2$ , and  $M_3$ . Two sets of resources are available for the same task in a farmland whose area is 3,880 m<sup>2</sup>. A set of resources contains the necessary machinery and labor for a farming

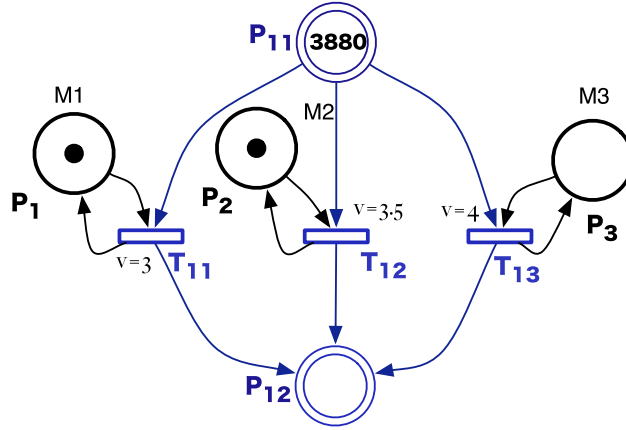

Fig. 3. Cooperative farming work

work. The working speed of resources  $M_1$ ,  $M_2$  and  $M_3$  is set to  $3 \text{ m}^2/\text{min}$ ,  $3.5 \text{ m}^2/\text{min}$ , and  $4 \text{ m}^2/\text{min}$ , respectively. The work time for this task is 9.95 h if the  $M_1$  and  $M_2$  are used simultaneously. However, if no token is assigned to  $P_2$ , the working time will be 21.56 h. Likewise, this model can well describe cooperative farming work in which the working velocity depends on the allocated resources.

### 3.3 Modeling for breaks in the farming work

The break time includes the time consumed by uncertainties such as machinery failure, poor weather and so on. The working procedure and breaks are modeled as shown in Fig. 4. In this figure, the continuous transition  $T_{11}$  denotes the execution of farming work if there is a token in a discrete place  $P_1$ , which indicates that the resource is ready for allocation. At the beginning, the system is in the break status since the token is in place  $P_2$ . The token is planned to be transmitted to  $P_1$  at 30 min by firing the discrete transition  $T_2$ , and then the farming work starts. At the time of 120 min, the system shifts into the break status by firing the transition  $T_1$  because a discrete transition has priority over a continuous transition. If we define the break time list for  $T_1$  and  $T_2$  beforehand, all breaks in the work can be described and modeled.

## 4 Formulating farming schedule based on hybrid Petri nets

Figure 5 shows simplified hybrid Petri nets for formulating a farming schedule.  $T_i$  corresponds to performing the work in three farmland with areas of  $3,880 \text{ m}^2$ ,  $980 \text{ m}^2$ , and  $1,300 \text{ m}^2$ .  $v_i$  is the combined velocity of work  $i$  by the assigned resources, which are marked as  $r_i$ . Resources  $r_1$ ,  $r_2$ , and  $r_3$  are possibly assigned



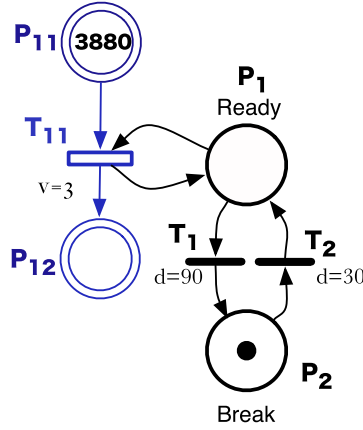

Fig. 4. Modeling for breaks in work

to any transition  $T_i$ . However, the work duration of  $r_i$  among all works cannot be superpositioned since a resource cannot be allocated to different farmlands at the same time.

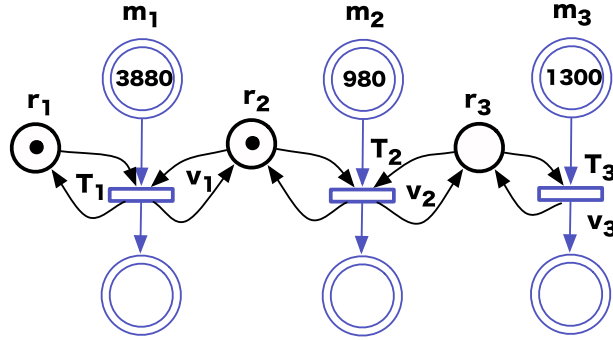

Fig. 5. Hybrid Petri nets for formulating farming schedule

In order to theoretically describe the strategy for allocating the resources to farming works, we define  $m_i$ ,  $r_i$ ,  $t_i$ , and  $v^{r_i}$  as the area of the farmland, resources used in the work, work time of  $r_i$  in farmland  $j$ , and working velocity of the resources, respectively.  $t_i^{r_j}(s)$  represents the start time of resource  $r_j$  working in the farmland  $i$ , and  $t_i^{r_j}(e)$  represents the end time. For any resource allocation scheme, the following equations exist:

$$\begin{aligned}
 m_1 &= [t_1^{r_1}(e) - t_1^{r_1}(s)] \cdot v^{r_1} + [t_1^{r_2}(e) - t_1^{r_2}(s)] \cdot v^{r_2} + \dots + [t_1^{r_h}(e) - t_1^{r_h}(s)] \cdot v^{r_h} \\
 m_2 &= [t_2^{r_1}(e) - t_2^{r_1}(s)] \cdot v^{r_1} + [t_2^{r_2}(e) - t_2^{r_2}(s)] \cdot v^{r_2} + \dots + [t_2^{r_h}(e) - t_2^{r_h}(s)] \cdot v^{r_h} \\
 &\vdots \\
 m_k &= [t_k^{r_1}(e) - t_k^{r_1}(s)] \cdot v^{r_1} + [t_k^{r_2}(e) - t_k^{r_2}(s)] \cdot v^{r_2} + \dots + [t_k^{r_h}(e) - t_k^{r_h}(s)] \cdot v^{r_h}
 \end{aligned}$$

The above equations can be organized as:

$$\begin{bmatrix} t_1^{r_1}(e) - t_1^{r_1}(s) & t_1^{r_2}(e) - t_1^{r_2}(s) & \cdots & t_1^{r_h}(e) - t_1^{r_h}(s) \\ t_2^{r_1}(e) - t_2^{r_1}(s) & t_2^{r_2}(e) - t_2^{r_2}(s) & \cdots & t_2^{r_h}(e) - t_2^{r_h}(s) \\ & & \vdots & \\ t_k^{r_1}(e) - t_k^{r_1}(s) & t_k^{r_2}(e) - t_k^{r_2}(s) & \cdots & t_k^{r_h}(e) - t_k^{r_h}(s) \end{bmatrix} \begin{bmatrix} v^{r_1} \\ v^{r_2} \\ \vdots \\ v^{r_h} \end{bmatrix} = \begin{bmatrix} m_1 \\ m_2 \\ \vdots \\ m_k \end{bmatrix}$$

To avoid the superposition of durations  $[t_a^{r_i}(s), t_a^{r_i}(e)]$  and  $[t_b^{r_i}(s), t_b^{r_i}(e)]$ , we have the following conditions:

$$\begin{aligned} \forall a, b, t_a^{r_i}(s) < t_a^{r_i}(e) \\ t_a^{r_i}(e) < t_b^{r_i}(s) \cdots \text{if } t_a^{r_i}(s) < t_b^{r_i}(s) \end{aligned}$$

The known vectors are  $[v^{r_1}, v^{r_2}, \dots, v^{r_h}]^T$  and  $[m_1, m_2, \dots, m_k]^T$ , and the solution is the work duration for resource  $r_i$  on work  $j$ . The objective of the scheduling problem is formulated as the following equation:

$$\min (\max_{i,j} t_i^{r_j}) \tag{3}$$

The proposed formulation will result in a mixed integer nonlinear programming (MINLP) problem if we consider a large number of variables and constraints (Zhang and Sargent, 1996). This optimization problem can be solved by several approaches such as problem-domain heuristics, Monte Carlo method, simulated annealing, genetic algorithm and tabu-search (Pham and Karaboga, 1998). Using hybrid Petri nets, however, major constraints arising in a scheduling problem can be formulated graphically, and there is no necessity to define any variable or constraint mathematically. As a result, a substantial reduction in the complexity of problem formulation is achieved (Ghaeli et al., 2005; Sadrieh et al., 2007). A detailed discussion on developing an approach to solving this problem is outside the scope of this paper.

## 5 Demonstration

In this section, we demonstrate farm work flow on hybrid Petri nets and simulate the work schedule on given variables.

### 5.1 Input variables

Table 1 shows the input variables for the demonstration.  $F_i$  denotes a farmland, where  $i$  is the number indicating the farmland.  $W_{i1}$  corresponds to the

Table 1  
Input data

Farmland	$F_1$	$F_2$	$F_3$	$F_4$	$F_5$
Area of farmland (m <sup>2</sup> )	3,880	980	1300	2100	2920
Work of plowing	$W_{11}$	$W_{21}$	$W_{31}$	$W_{41}$	$W_{51}$
Machinery for plowing [Velocity (m <sup>2</sup> /min)]	$M_{11}, M_{12}, M_{13}$ [ $v_{11} = 3, v_{12} = 3.5, v_{13} = 4$ ]				
Work of planting	$W_{12}$	$W_{22}$	$W_{32}$	$W_{42}$	$W_{52}$
Machinery for planting [Velocity (m <sup>2</sup> /min)]	$M_{21}, M_{22}$ [ $v_{21} = 3.5, v_{22} = 4$ ]				

Table 2  
Resource allocation

Farmland	$F_1$	$F_2$	$F_3$	$F_4$	$F_5$
Resources for plowing	$M_{11}, M_{12}, M_{13}$	$M_{11}$	$M_{11}$	$M_{12}$	$M_{13}$
Working time (h)	6.16	5.44	7.22	10.00	12.17
Resources for planting	$M_{21}, M_{22}$	$M_{22}$	$M_{21}$	$M_{21}$	$M_{22}$
Working time (h)	9.95	4.67	7.22	11.67	13.90

work of plowing, and  $W_{i2}$  corresponds to the work of planting in farmland  $F_i$ . Work  $W_{i2}$  can only start after work  $W_{i1}$  is completed. The waiting time for farmland  $F_i$  is set to zero, that is, work  $W_{i2}$  can start immediately after work  $W_{i1}$  is completed.

Three machinery  $M_{11}, M_{12}, M_{13}$  are employed to carry out work  $W_{i1}$ , and two machinery  $M_{21}, M_{22}$  carry out work  $W_{i2}$ . The average working velocity  $v_{ij}$  is designated under the assumption that  $v_{ij}$  depends on the power of the machinery, but not on the status of the farmland. Velocity  $v_{ij}$  is estimated values considering conventional break times, lunching times, and moving times. The average working velocity for  $M_{11}$  is 3 m<sup>2</sup>/min for plowing.

The assignment of resources to the farm works are listed in Table 2. For the work of plowing in farmland  $F_1$ ,  $M_{11}, M_{12}, M_{13}$  are designated to perform cooperative work. The conditions of cooperative work require that work goes on uninterrupted until completion. The average working velocity of the cooperative work is the average working velocity of these three resources, and the work time to complete the work of plowing in  $F_1$  is estimated as 6.16 h. For the work of plowing in other farmland, the assigned resource work individually. The assignment of the resources for the work of planting is similar to that for the work of plowing.

Table 3  
Work lists of resources

Resource	Work List
$M_{11}$	$W_{11}, W_{21}, W_{31}$
$M_{12}$	$W_{11}, W_{41}$
$M_{13}$	$W_{11}, W_{51}$
$M_{21}$	$W_{12}, W_{22}, W_{52}$
$M_{22}$	$W_{12}, W_{32}, W_{42}$

The work list of each resource shown in Table 3 is generated by referring to Table 2. According to the work list, resource  $M_{ij}$  are planned to perform the works listed on the right column of the table in sequence.

### 5.2 Modeling schedule and monitoring system state

From the data stated above, we illustrate a hybrid Petri nets system shown in Fig. 6 for scheduling. In order to distinctly show the entire model, we ignore the naming of discrete places and transitions. The naming of continuous transitions is reset to  $T_n (n = 1, 2, \dots, 25)$ . For example,  $T_1, T_2, T_3$  correspond to performing farm work  $W_{11}$  by assigned resources  $M_{11}, M_{12}$ , and  $M_{13}$ . Similarly,  $T_4, T_5$  correspond to performing farm work  $W_{12}$  by assigned resources  $M_{21}$  and  $M_{22}$ .

For each farmland  $F_i$ , there are three places  $P_{i1}, P_{i2}, P_{i3}$  denote three states of the farmland.  $P_{i1}$  indicates that farmland  $F_i$  is ready for plowing work  $W_{i1}$ . When the value in place  $P_{i2}$  reaches the initial value in  $P_{i1}$ , the work of plowing  $W_{i1}$  is completed and the farmland is ready for the next work of planting ( $W_{i2}$ ). Here, we ignore the waiting time for each place  $P_{ij}$ .

Each transition  $T_n$  is connected with arcs between the discrete and continuous input and output places. The transition  $T_n (n < 6)$  is enabled, and it fires at time  $t = 0$ ; this indicates that the corresponding work is being carried out. The firing operation can be broken and resumed when a specified time is reached. The completed firing of  $T_n$  results in a new state where the value in the former continuous place becomes zero while that in the latter place increases. The token in the discrete place is simultaneously transmitted to the next place for the next work in the work list. For instance, after completion of work  $W_{11}$ , the discrete tokens in the places connected to  $T_1, T_2, T_3$  are transmitted to a discrete place connected to  $T_6, T_{17}$ , and  $T_{23}$ , respectively. In succession, the work of plowing starts in farmlands  $F_2, F_4$ , and  $F_5$ . Likewise, the work schedule using the sequence in the work list is graphically simulated on the hybrid Petri nets system.

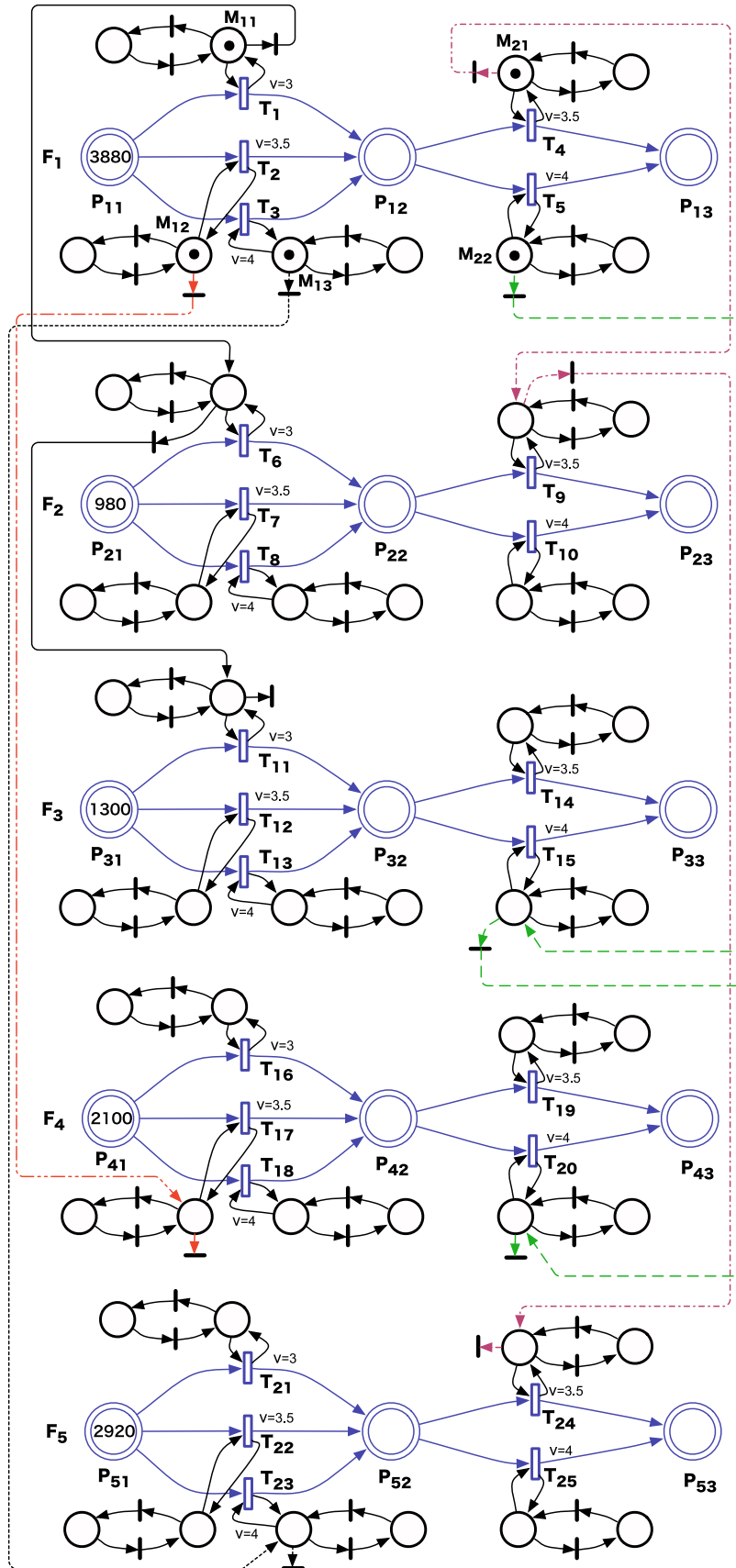

Fig. 6. Hybrid Petri nets modeling for schedule

In a workday where the work times are 8:00–12:00 and 13:00–17:00, conventional breaks are designated roughly, as shown in Fig. 7. The figure describes the farming activities in common agricultural corporations. They require the time for moving to the farmland, breaks during farming work, lunch time, and time for cleaning up. Therefore, the actual working time in a workday is approximately 7 h (8:30–10:00, 10:15–12:00, 13:00–15:00 and 15:15–16:30).

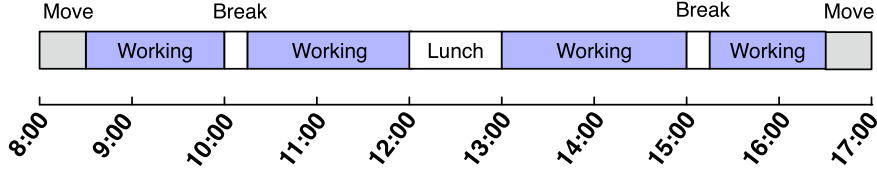
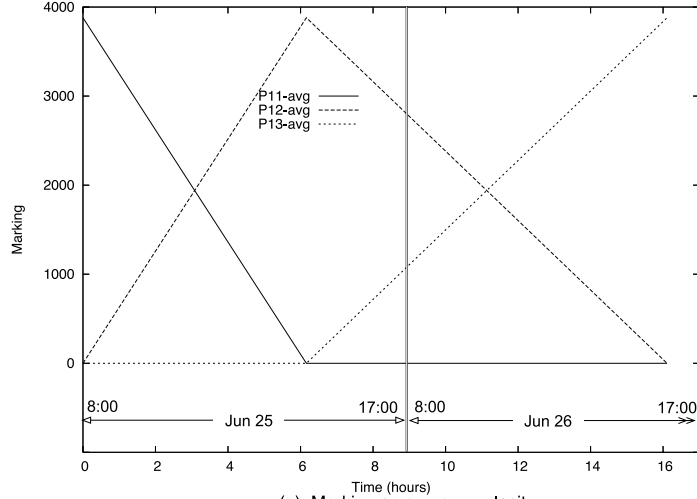

Fig. 7. Break time in workday

Figure 8 shows the tracing of markings on the average working velocity and breaks in farmland  $F_1$ . The vertical axis depicts the amount of tokens in places, that are areas available for carrying out the next work. The unit for the  $y$ -axis is set to square meters ( $\text{m}^2$ ). Figure 8(a) describes the migration of tokens in places  $P_{11}, P_{12}, P_{13}$ , in which the firing velocity is the average working velocity of the assigned resources. The migration of the tokens denotes the changes in the completed area in the corresponding place. The axis  $x$  represents the accumulative time in hours from time  $t = 0$ . According to Table 2, resources  $M_{11}, M_{12}, M_{13}$  are assigned to the work of plowing in farmland  $F_1$ . The table depicts that  $T_1, T_2, T_3$  are enabled for the firing operation, and all works start at time  $t = 0$ . Along with the execution of plowing, the tokens in place  $P_{11}$  decreases while those in  $P_{12}$  increase at the average work velocity of the three resources. At  $t = 6.16$ , the tokens in places  $P_{11}, P_{12}$  become 0 and 3,880, respectively, and the work of plowing in this farmland is completed. The next work of planting can then be started since the waiting time for farmland  $F_1$  is assumed to be zero and the resources for this work are available.

In the Fig. 8(a), we divide the time into two parts on workdays June 25 and June 26 by converting the accumulative time to the workday. However, the detailed changes in markings during the work cannot be distinctly represented. We show another marking tracing in Fig. 8(b) for observation of the break time. The marking curves of  $P_{11}, P_{12}$  and  $P_{13}$  remain straight during the break time. The actual velocity of the work is greater than the average velocity. The sum of the marking at the three places is constant, that is the area of farmland  $F_1$ .

Since the marking of the hybrid Petri nets is subject to Equation (2), monitoring the marking of the system implies that we monitor the farming progress, the state of the farmland and resources.



(a) Marking on average velocity

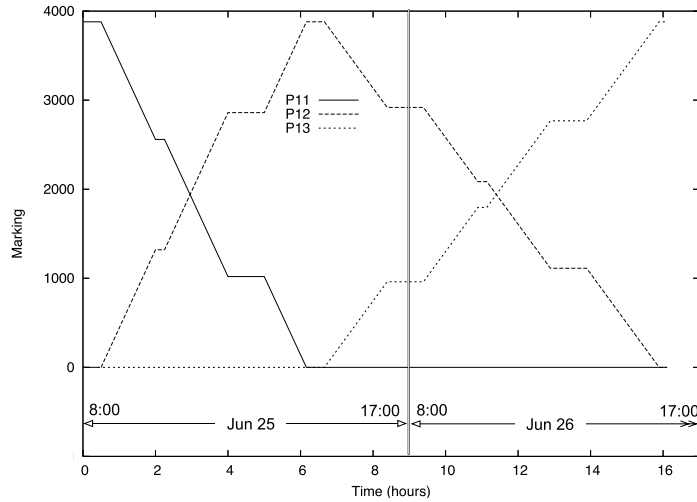

(b) Marking on breaks

Fig. 8. Marking tracing for average working velocity and break time

In order to further comprehensively illustrate the generated schedule, we show the schedule derived from the average work velocity by a Gantt chart (Fig. 9). The individual bars correspond to works and their lengths depict the duration of work with the allocated resource. The links between two bars represent *precedence constrained* relation (Chekuri and Motwani, 1999); in other words, a latter work can only start after the completion of a former one. The resources are displayed on the right side of the bars. The idle time between  $W_{12}$  on  $M_{21}$  and  $W_{22}$  on  $M_{21}$  appears in the graph because of the waiting time for the completion of  $W_{31}$  on  $M_{11}$ . Although a Gantt chart supports the visual representation of the progress for displaying the cumulative percentage of task completion, the progress lines are not displayed in this Gantt chart at the start of the schedule.

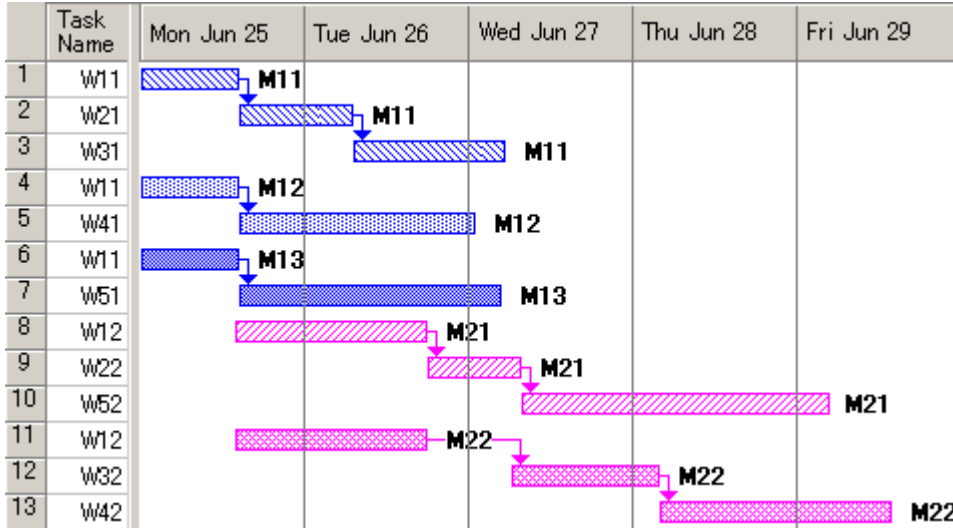

Fig. 9. Generated schedule displayed as Gantt chart

## 6 Discussion

In this study, a hybrid Petri nets model was proposed for modeling farm work flow in agricultural corporations. Conventional activities such as the cooperative work and breaks caused by uncertainties during the farming process were taken into consideration. The scheduling problem was formulated for dealing with cooperative work, and the visual representation of the created schedule were demonstrated on Petri nets and a Gantt chart. We assumed that there was no additional limitation for assigning resources to a work, and we ignored the moving distance between farmlands. The simulated schedule was obtained based on the work list, and the data for simulation were obtained from a sugarcane-producing corporation.

We modeled the farm work flow and simulated how the farm work schedule was generated on a hybrid Petri nets model. In the demonstration, the hybrid Petri nets exhibited superiority in modeling farm work flow while considering uncertainties and cooperative work. The resource constraints and conditions were well modeled graphically on the Petri nets model. From the markings of the hybrid Petri nets system, not only the initial state but also the progressive state of the farmland and resources was illustrated in the hybrid Petri nets model. We implemented resource allocation only by managing the tokens in the places of the net model.

The work flow in sugarcane production, any breaks, and cooperative work were adequately modeled by hybrid Petri nets. The considered uncertainties in the farming work involved the cancellation of farming work and the changes in resources such as labor and machinery, the state of the farmland, and the weather. Cancellation of the farming work might be caused by problems such



as machinery failure and poor weather. Continuous places, which indicate the state of the farmland, were set to not have a waiting time, and the resources defined in the demonstration comprised a set of the minimum necessary machinery and labor for the farm work. However, the number of farming works in a farmland is not invariable and the entry time of cooperative work is random in practical farming work. The waiting time after which the farmland becomes available for the next farm work, after completion of present farm work in a farmland, should also be specified in advance. Moreover, assigning individual resources to a work instead of a set of resources is conducive to flexibly planning farm work. In the case of individual resources, each discrete place connected to continuous transitions in the net model of Fig. 6 should be further divided into several subdivisions corresponding to the number of resources. Therefore, elementary hybrid Petri nets are still insufficient for modeling all behaviors in farming work, and we should consider a more detailed net model for describing the timed and stochastic events.

In general, the farm work planning problem is difficult to formulate by conventional methods if we consider resource constraints and conditions. The hybrid Petri nets model greatly reduces the problem formulation complexity (Sadrieh et al., 2007); however, the farm work planning is not optimized by the Petri nets model. The strategies of allocating resources and scheduling based on a priority list of tasks are generally used to optimize farm work planning, and Petri nets are used to model the progressive status of the entire system, including resources, conditions, and works. This paper does not involve the strategies for allocating resources and creating a priority list in which works are arranged according a specific priority. In this demonstration, simulated data of resources allocation (Table 3) and the task list (Table 2) were simply defined in advance. The assigned resources and the tasks in the work lists correspond to the discrete tokens and continuous transitions of the hybrid Petri nets, respectively. Moreover, the schedule length, which is the time period between the start of the first task and the completion of the last task, were calculated according the firing rule of Petri nets. The goals of modeling of farm work flow, solution of resource constraints, calculation of schedule length, and system monitoring were achieved on the Petri nets model.

The strategy of reallocating resources is also very important for farm work planning when resources are updated. The changes in resources mainly include the purchase of new machinery, employment of the labor, upgrading of resource efficiency and reduction in available resources. The reallocation of discarded machinery and resources that are released by some uncertainties must also be considered. In the case of discarded machinery, the token in the net model of Fig. 6 vanishes and some transitions (farm works) may not fire; therefore, the schedule needs to be renewed. These situations must be taken into account for reallocating resources.

Simulation data used in the demonstration did not cause deadlocks in the system, a situation where two or more competing works await the release of resources and neither obtains the necessary resources. In the practical construction of farm work planning, assigning farm works based on a priority list could possibly result in deadlock. We suggest the following schemes to avoid deadlock: (1) specify the rank of a work in a farmland by observing the farmland situation, (2) define the rank of resources by their efficiency, and (3) preferably have short moving distance for resources between farmlands.

Our research term has performed some related works on constructing farm work planning. We have constructed a database for storing experimental data from sugarcane-producing corporations. The data include the information on the farmland, resource definitions and quantity, daily work data and so on. Daily progressive data, location of farmlands, and the data on changes in uncertainties were recorded using cellular phones (Guan et al., 2006b). The data are applicable not only to the production of sugarcane, but also to the production of other crops, such as paddy, wheat, and vegetables. Algorithms to calculate an optimal schedule are planned to be developed based on meta-heuristic algorithms. In these algorithms, we will attempt to make the scheduling algorithm robust against environmental changes and deviations from the last generated farm work plan. We will also characterize the farm work planning problem into multiple objective problems based on the schedule length, moving distance, preference work and so on.

## **7 Conclusions**

Planning daily farm work requires a rational model. In order to satisfy this requirement, we introduced a hybrid Petri nets model for modeling farm work flow in an agricultural corporation. A simulation revealed that hybrid Petri nets are applicable to modeling farm work flow while considering activities such as cooperative work and breaks caused by uncertainties in the farming process. This model can be applied to construct a practical farm work plan in some agricultural corporations.

## **8 Acknowledgments**

This study was supported by a grant of the research project for utilizing advanced technologies in agriculture, forestry, and fisheries from the Ministry of Agriculture, Forestry and Fisheries of Japan.

## References

- Arjona, E., Bueno, G., Salazar, L., 2001. An activity simulation model for the analysis of the harvesting and transportation systems of a sugarcane plantation, *Computers and Electronics in Agriculture*, 32, 247–264
- Chekuri, C., Motwani, R., 1999. Precedence constrained scheduling to minimize weighted completion time on a single machine, *Discrete Applied Mathematics*, 98, 29–39
- Chen, L. H., McClendon, R. W., 1985. Soybean and Wheat Double Cropping Simulation Model, *Transaction of the ASAE*, 28(1), 65–69
- Cottrel, W.D., 1999. Simplified Program Evaluation and Review Technique (PERT), *Journal of Construction Engineering and Management*, 125(1), 16–22
- Daikoku, M., 2005. Development of computer-assisted system for planning work schedule of paddling and transplanting in distributed fields, *Japanese Journal of Farm Work Research*, Vol. 40(4), 210–214 (In Japanese)
- David, R., Alla, H., 2001. On hybrid Petri nets, *Discrete Event Dynamic Systems*, 11, 9–40
- Djordjevic, G.L., Tosic, M.B., 1996. A heuristic for scheduling task graphs with communication delays onto multiprocessors, *Parallel Computing*, 22, 1197–1214
- Dotoli, M., Fanti, M.P., Giua, A., Seatzu, C., 2007. First-order hybrid Petri nets. an application to distributed manufacturing systems, *Nonlinear Analysis: Hybrid Systems*, doi:10.1016/j.nahs.2006.05.005
- Febbraro, A. D., Sacco, N., 2004. On modelling urban transportation networks via hybrid Petri nets, *Control Engineering Practice*, 12, 1225–1239
- Ghaeli M., Bahri, P. A., Lee, P. L., 2005. Timed arc hybrid Petri nets based scheduling of mixed batch/continuous plants, *Proceedings of the 17th IMACS World Congress*, Paris, France
- Guan, S., Matsuda, H., Shikanai, T., Nakamura, M., 2006a. Petri nets modeling and scheduling for farm work planning, *International Technical Conference on Circuits/Systems, Computers and Communications*, Vol. II, 465–468
- Guan, S., Shikanai, T., Minami, T., Nakamura, M., Ueno, M., 2006b. Development of a system for recording farming data by using a cellular phone equipped with GPS, *Japanese Society of Agricultural Informatics*, 15, 241–254
- Haffar, I., Khoury, R., 1992. A computer model for field machinery selection under multiple cropping, *Computers and Electronics in Agriculture*, 7, 219–229
- Higgins A., Davies, I., 2005. A simulation model for capacity planning in sugarcane transport, *Computers and Electronics in Agriculture*, 47, 85–102
- Kaakai, F., Hayat, S., Moudni, A. E., 2007. A hybrid Petri nets-based simulation model for evaluating the design of railway transit stations, *Simulation Modelling Practice and Theory*, doi:10.1016/j.simpat.2007.05.003

- Lal, H., Peart, R. M., Jones, J. W., Shoup, W. D., 1991. An object-oriented field operation simulator in PROLOG, *Transaction of the ASAE*, 34(3), 1031–1039
- Miles, G. E., Tsai, Y. J., 1987. Combine Systems Engineering by Simulation, *Transaction of the ASAE*, 30(5), 1277–1281
- Murata, T., 1989. Petri nets: properties, analysis and applications, *Proceedings of the IEEE*, 77 (4)
- Nanseki, T., 1998. Operations of FAPS97: a decision support system for evaluating agricultural technology and farm planning, *Misc. Publ. Tohoku Natl. Agric. Exp. Stn.* 21, 1–119 (In Japanese)
- Nanseki, T., Matsushita, S., Ikeda M., 2003. A Farming-systems data base for farm planning, *Japanese Society of Agricultural Informatics*, 12, 133–152 (In Japanese).
- Pham, D.T., Karaboga, D., 1998. *Intelligent optimization techniques: genetic algorithms, tabu search, simulated annealing and neural networks*, Springer, Berlin
- Sadrieh, S.A., Ghaeli, M., Bahri, P.A., Lee, P.L., 2007. An integrated Petri nets and GA based approach for scheduling of hybrid plants, *Computers in Industry*, 58, 519–530
- Sinnen, O., Sousa, L., 2001. Scheduling task graphs on arbitrary processor architectures considering contention, In *Int. Conf. on High Perf. Computing and Networking*, *Lecture Notes in Computer Science*, 2110, 373–382
- The Ministry of agriculture, forestry and fisheries of Japan, 2006. *Japan's Post-war Agricultural Land Reform and Subsequent Agricultural Land System*, National Report for the International Conference on Agrarian Reform and Rural Development
- Tsai, Y. J., Jones, J. W., Mishoe, J. W., 1987. Optimizing Multiple Cropping Systems: A Systems Approach, *Transaction of the ASAE*, 30(6), 1554–1561
- Zhang, X., Sargent, R.W.H., 1996. The optimal operation of mixed production facilities - a general formulation and some approaches for the solution, *Computers & Chemical Engineering*, 20, 897–904